

**OXIDAL**  
your\_project\_partner

pensilinecanopies



mira + light



Mira è il sistema pensilina con profilo di sostegno a muro che permette di realizzare pensiline in vetro dall'aspetto contemporaneo e minimale.

Il sistema prevede vari accorgimenti tecnici tra cui il sistema di raccolta delle acque piovane integrato, che permette di convogliare le acque in un unico punto di sgorgo, e la predisposizione per l'inserimento dell'illuminazione Led sia nella parte inferiore, per l'illuminazione del passaggio pedonale, che all'interno del profilo, in corrispondenza dello spessore del vetro

Il sistema è facile da installare e non richiede né tacche né forature sul vetro. I profili sono disponibili in finitura alluminio, simil inox e a richiesta in altre finiture.

Certificato in base alle attuali normative.

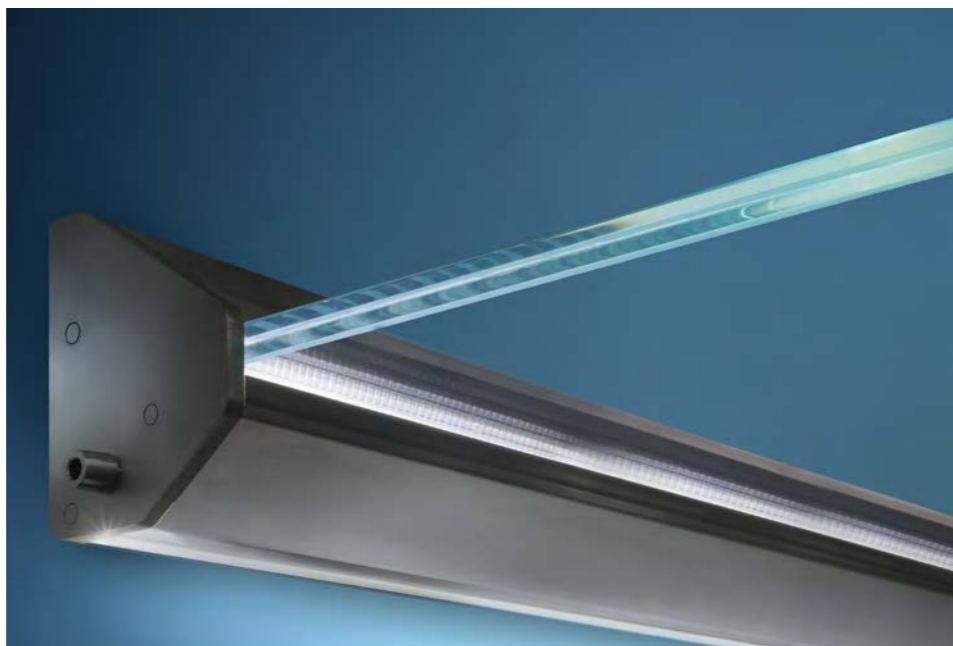

Mira is a canopy system with wall supporting profile that allows to realize glass canopies with contemporary and minimalist looking.

The system provides various technical features including the rainwater collection system, that allows to direct the water into a single point of gush, and the predisposition for Led lighting that could be inserted into the lower part, for the pedestrian crossing illumination, and inside the profile, in correspondence with the glass thickness

The system is easy to install and doesn't requires notches or holes on the glass. The profiles are available in aluminum and chrome mat finish, on request in other finishes.

Certified according to current regulations.

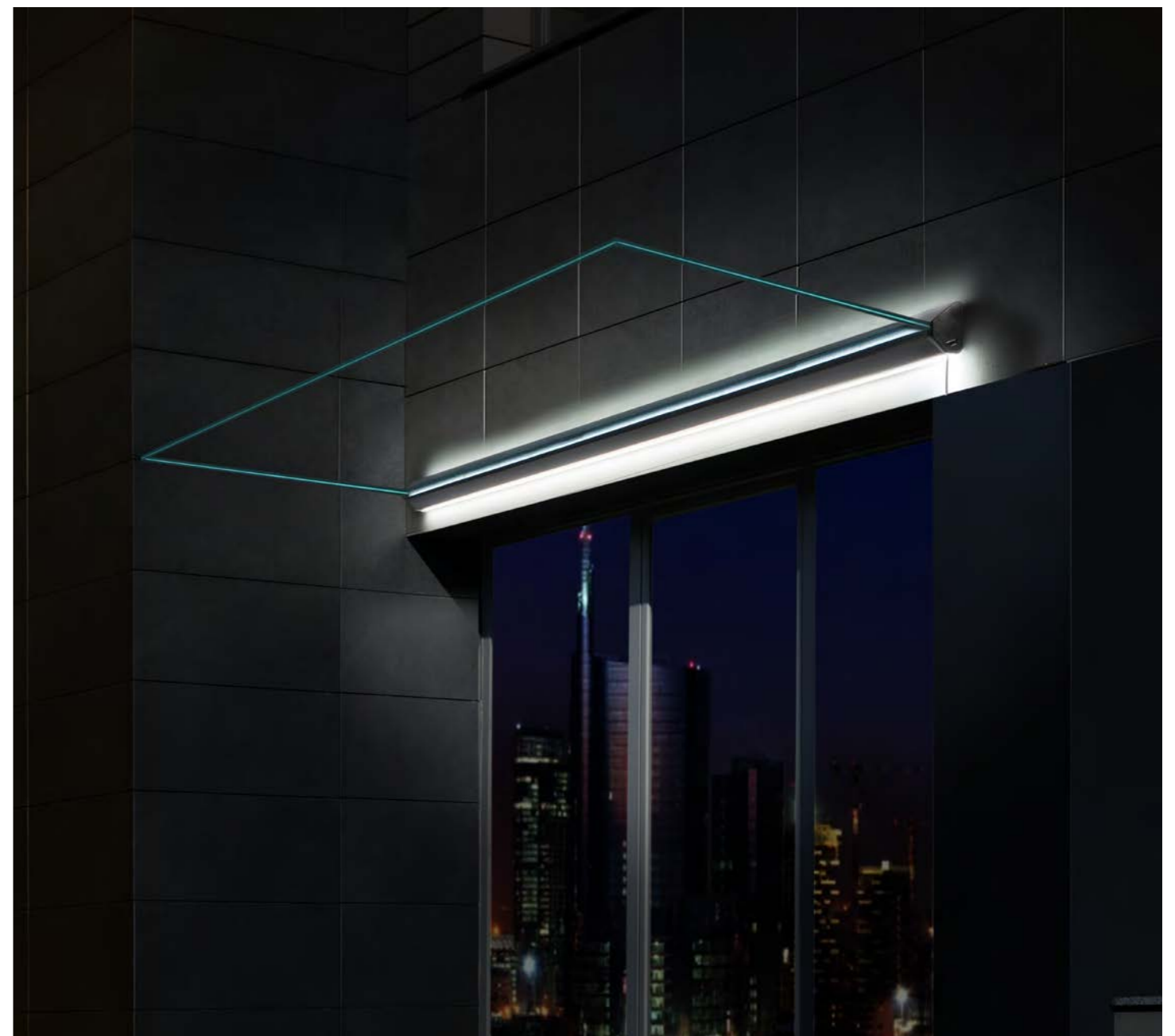

## Istruzioni per il montaggio / Instructions for assembly

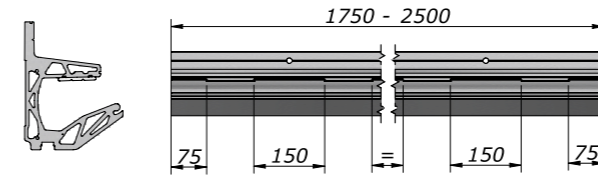
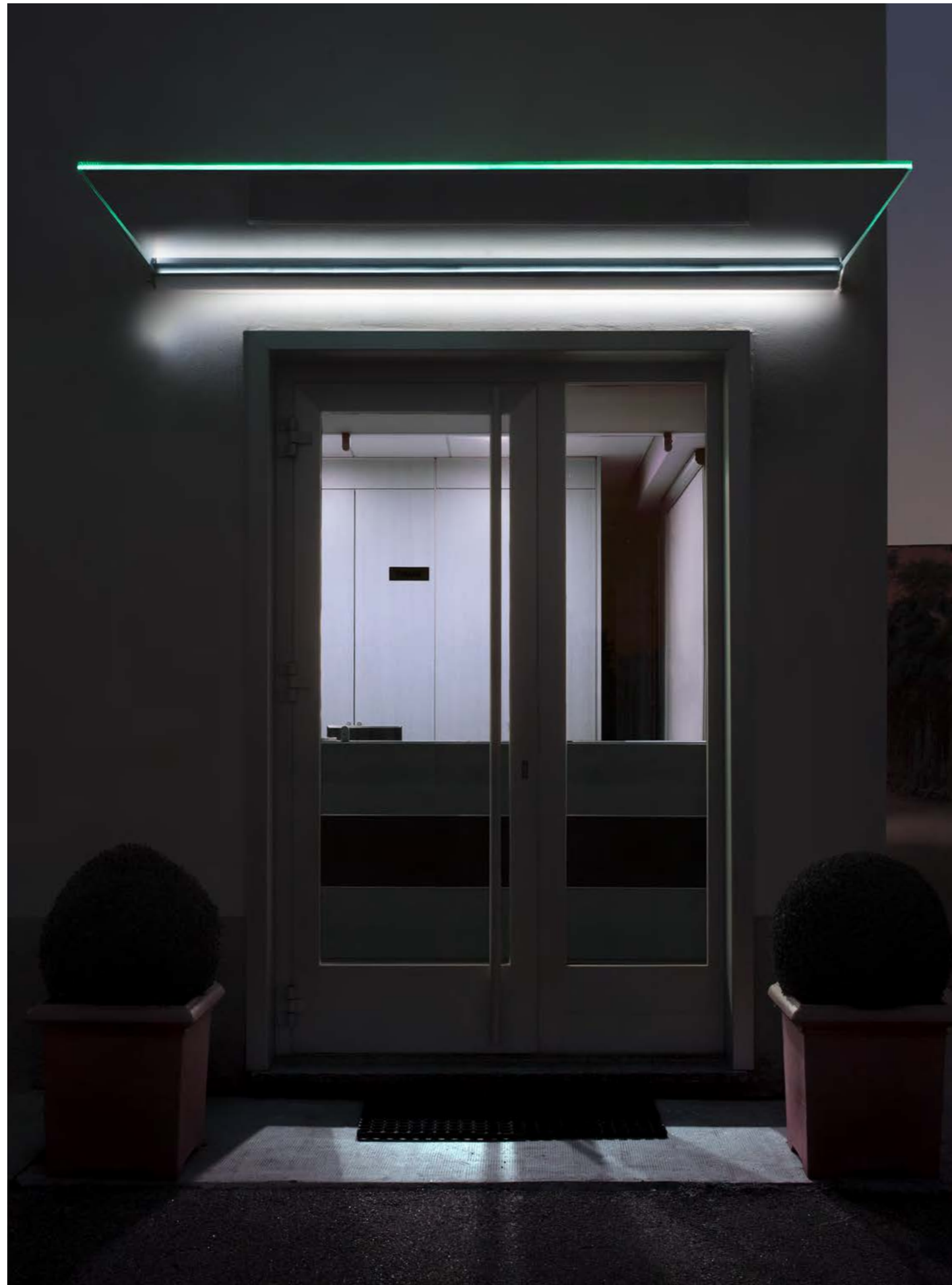

1. Inserire le guarnizioni superiori (contenute nel kit Art. AC60/61) sul profilo Mira.  
 Insert the upper gaskets on Mira profile (included in gasket set Art. AC 60/61).

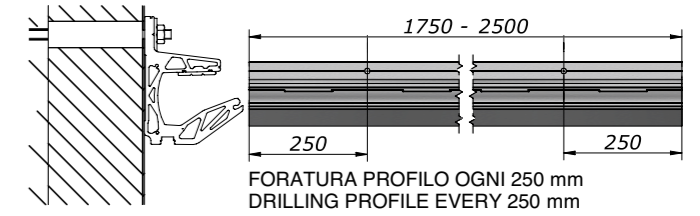

2. Fissare il profilo Mira a parete utilizzando tutti i fori di fissaggio, utilizzare viti o tasselli adeguati alla tipologia di materiale e al carico. Se necessario inserire appositi distanziali tagliati a misura (art. AC 64).  
 Fasten Mira profile to the wall using all mounting holes, use appropriate screws or anchors according to the type of material and load. If it's need use spacers Art. 64 cut by size needed.

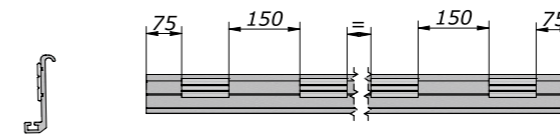

3. Inserire le guarnizioni inferiori (contenute nel kit AC60/61) sul profilo di supporto vetro.  
 Insert the bottom gaskets on glass supporting profile (included in gasket set Art. AC 60/61).

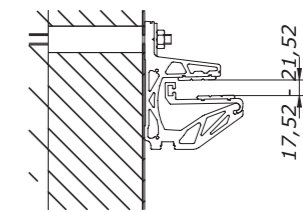

4. Installare il profilo di supporto vetro sul profilo Mira.  
 Install the glass supporting profile on Mira profile.

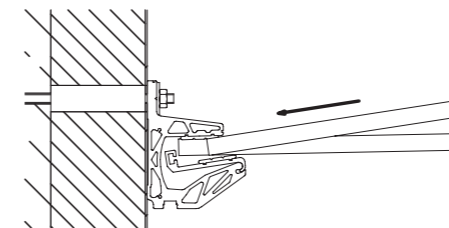

5. Installare il vetro: appoggiare la lastra sul profilo di supporto vetro, inclinarla e farla scorrere all'interno fino a contro la battuta posteriore; riportare la lastra in posizione orizzontale in modo che anche il profilo di supporto si posizioni orizzontalmente.  
 Install the glass: place the glass sheet on the glass supporting profile, inclined and slid it until the complete insertion against the back stop. Bring the glass sheet back in horizontal position so that the supporting profile moves in horizontal position as well.

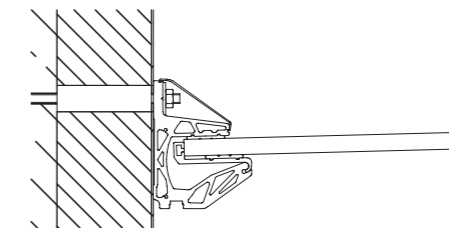

6. Installare il carter di copertura superiore.  
 Install the top cover profile.

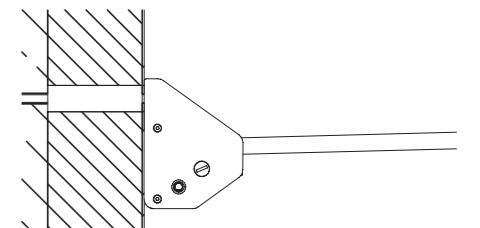

7. Installare i tappi laterali.  
 Install the lateral end caps.

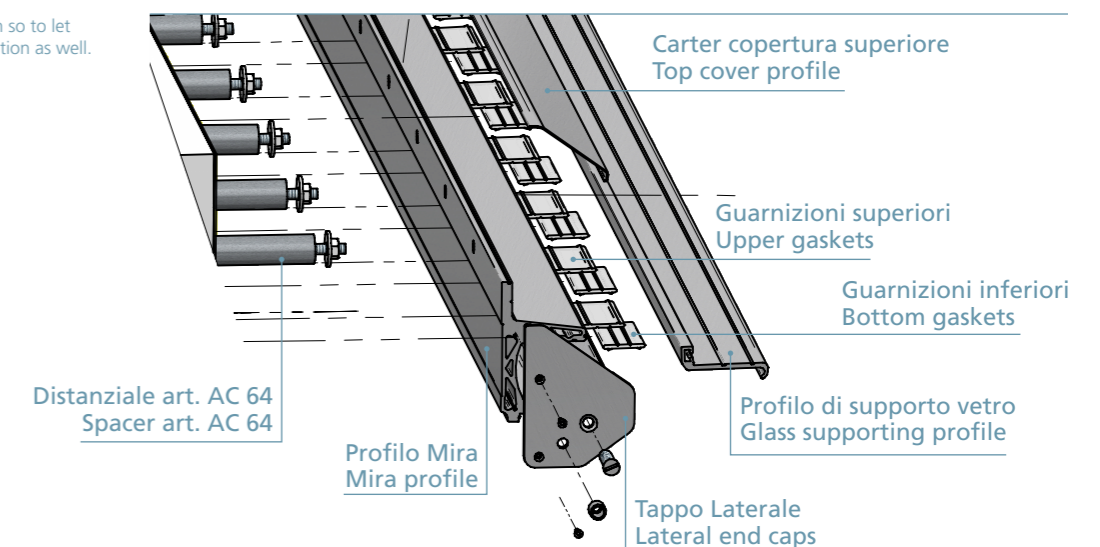

**MIRA**

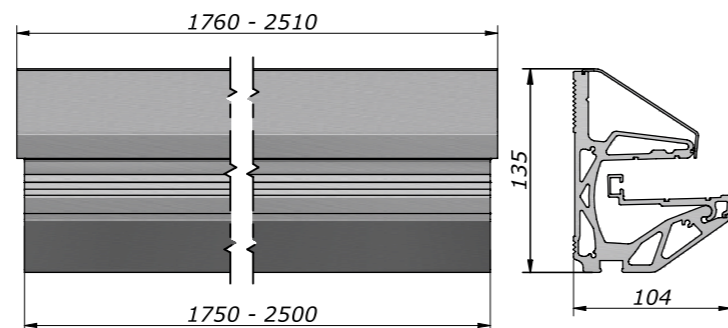
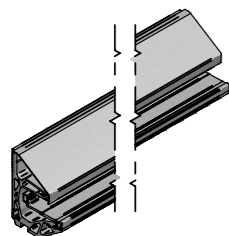

Profilo pensilina completo di carter di copertura  
Caonpy fixing profile with covers

argento/silver L. 1750 mm	argento/silver L. 2500 mm	cromato satinato/chrome mat L. 1750 mm	cromato satinato/chrome mat L. 2500 mm
Mira-A-175	Mira-A-250	Mira-I-175	Mira-I-250

**AC60**

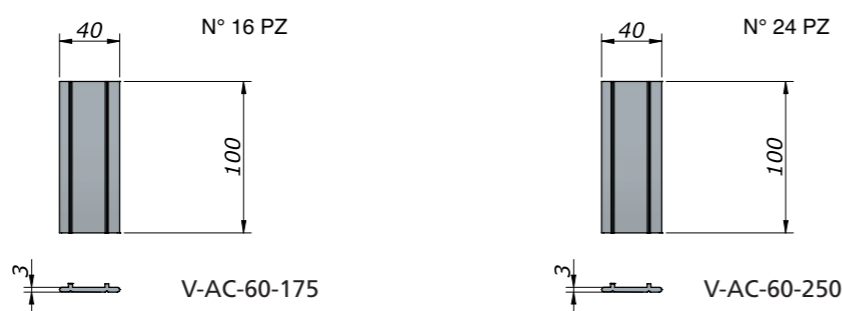

Set guarnizioni per sp. 8+8 mm  
Gaskets set for glass thickness 8+8 mm

per profilo lungh. 1750 mm / for profile with length 1750 mm	per profilo lungh. 2500 mm / for profile with length 2500 mm
V-AC-60-175	V-AC-60-250

**AC61**

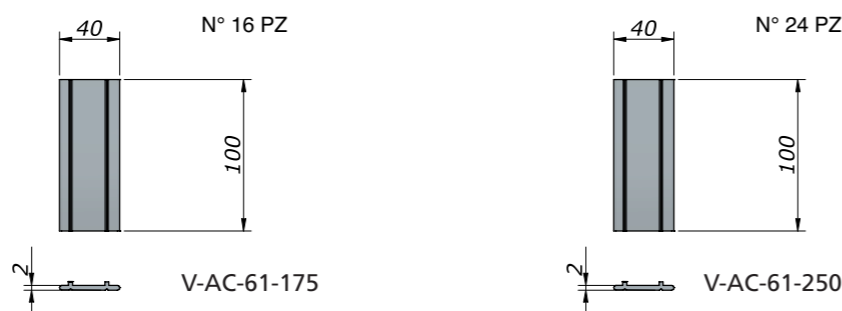

Set guarnizioni per sp. 10+10 mm  
Gaskets set for glass thickness 10+10 mm

per profilo lungh. 1750 mm / for profile with length 1750 mm	per profilo lungh. 2500 mm / for profile with length 2500 mm
V-AC-61-175	V-AC-61-250

**AC62**

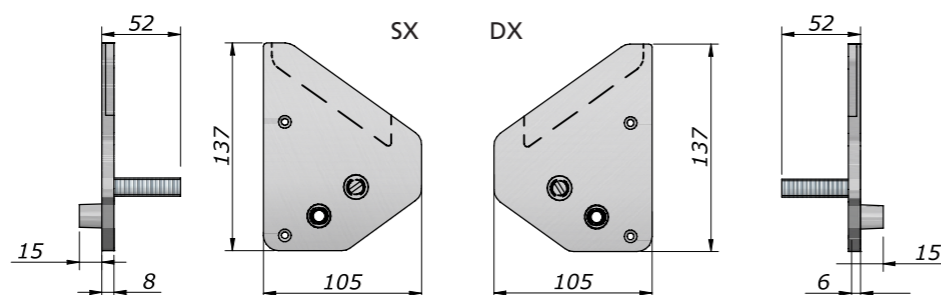
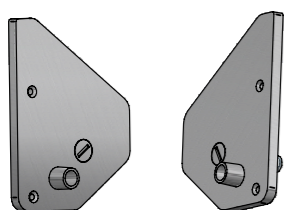

Tappo laterale  
Lateral cap

argento destro/silver right	argento sinistro/silver left	cromato satinato destro/chrome mat right	cromato satinato sinistro /chrome mat left
V-AC-62-A-DX	V-AC-62-A-SX	V-AC-62-I-DX	V-AC-62-I-SX

**AC63**

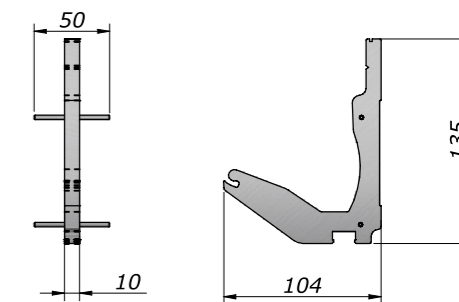
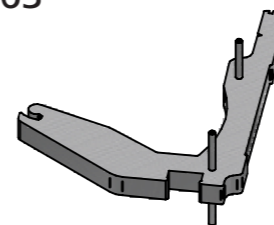

Giunto centrale  
Central joint

argento /silver	cromato satinato/chrome mat
V-AC-63-A	V-AC-63-I

**AC64**

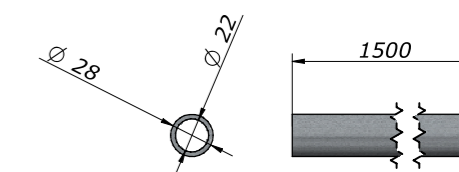

Distanziale per cappotto  
Spacer for extrnal insulating

lungh. 1500 mm / length 1500 mm
V-AC-64

**AC65**

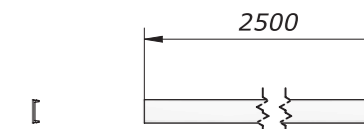
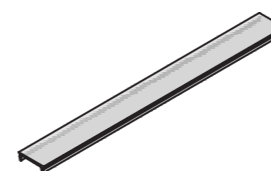

Profilo diffusore  
Light diffuser profile

lungh. 2500 mm / length 2500 mm
V-AC-65

**AC66**



Led bianco 4000k, 15W/M (luce fredda)  
White led strip 4000k, 15W/M (cold light)

V-AC-66
---------

**AC67**



Led Multicolor 4000k, 15W/M  
Multicolor led strip 4000k, 15W/M

V-AC-67

**AC68**



Alimentatore  
Power supply

V-AC-68

**AC69**



Controller RGB  
controller RGB

V-AC-69



light



Light è la linea di accessori per pensiline realizzata in acciaio inox Aisi 316 L, studiata per coniugare le esigenze di resistenza meccanica ad una elegante linea estetica. La gamma comprende, oltre ai supporti a muro e a vetro, tappi che consentono la copertura dei tasselli di fissaggio e specifiche viti articolate le cui linee si armonizzano perfettamente con il resto degli accessori. L'assenza di bulloni e viti a vista dona a tutta la struttura un aspetto raffinato e differenzia nettamente la serie Light dagli altri prodotti presenti sul mercato.

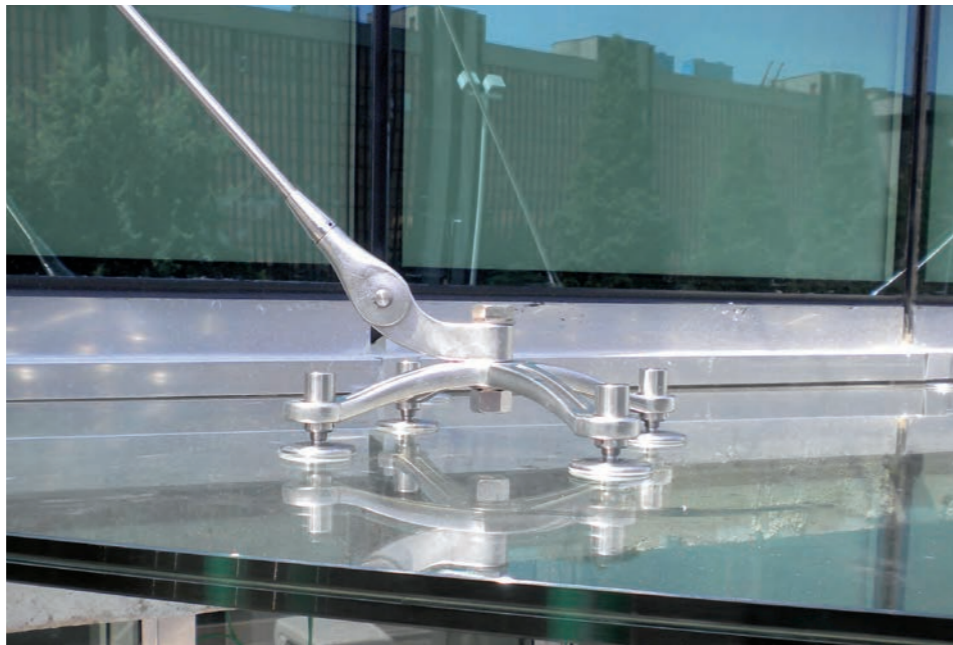

Light is the series of accessories for canopies made of stainless steel Aisi 316 L, studied to combine the needs of mechanical strength with an elegant aesthetic line. In addition to the wall and glass supports, the range includes cups that allow the coverage of the fixing dowels and specific articulated screws whose line blend perfectly with the rest of the accessories. The absence of bolts and screws at sight gives to the whole structure a refined aspect and let Light series differ markedly from the other products available on the market.



Esempi di installazioni / Installation solutions examples

Pensilina singola standard  
Standard single canopy

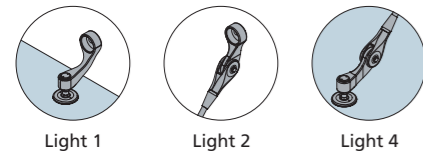
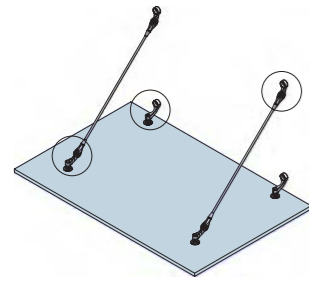

Pensilina singola con tiranti incrociati  
Cross rod single canopy

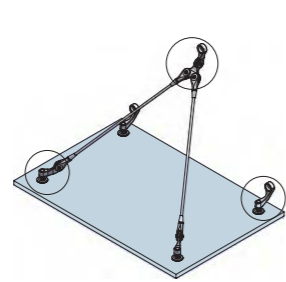

Pensilina singola con tirante di supporto centrale  
Single canopy with additional central rod

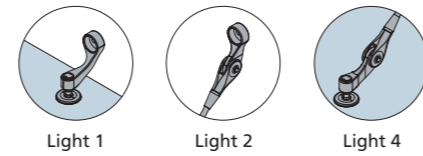
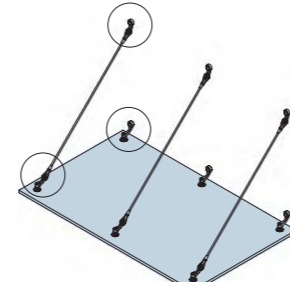

Pensilina doppia standard  
Standard Double canopy

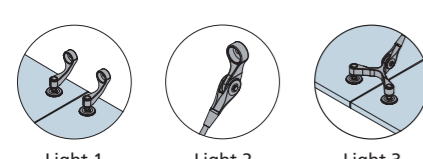
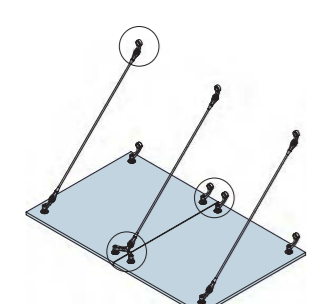

Pensilina doppia con tiranti incrociati  
Cross rod double canopy

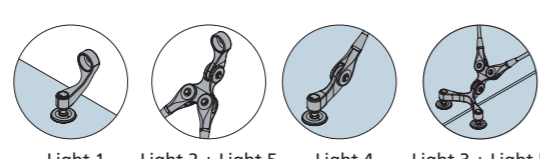
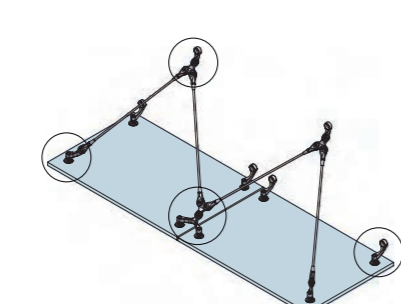

Pensilina angolare  
Corner canopy

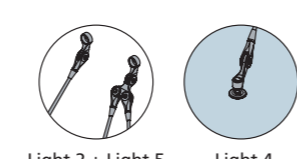
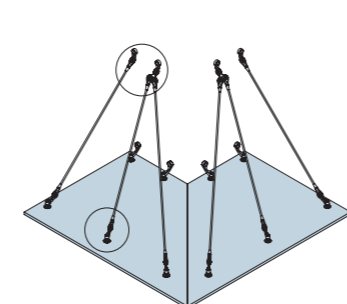

Dimensionamento vetro / Glass dimensioning

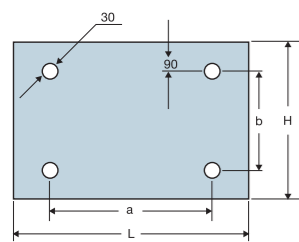

Esempi di dimensionamento / Examples of dimensioning

Lastre con 4 fori / Glass with 4 holes

L	H	a	b
1200	800	1000	600
1500	1050	1200	850
1800	1200	1300	1000
800	1200	600	1000
1050	1500	800	1250

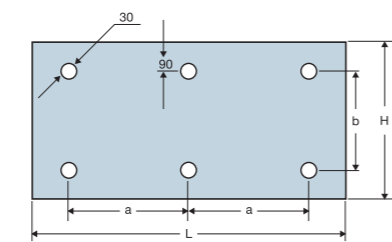

Lastre con 6 fori / Glass with 6 holes

L	H	a	b
2000	1200	900	1000
2500	1200	1100	1000
3200	1200	1300	1000
3200	1500	1300	1200

Dimensionamento tirante / Rod dimensioning

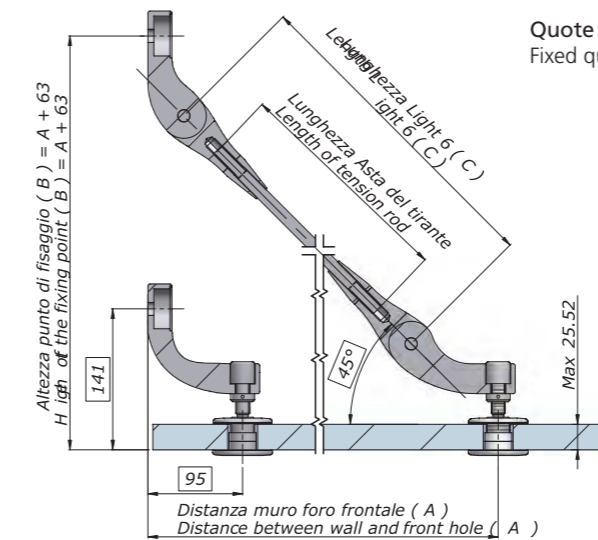

Quote fisse  
Fixed quotatas

Spessore consigliato:  
Temperato 10+  
Indurito 10 (pvb 1,52)  
oppure Temperato 10+  
Temperato 10 (pvb 1,52)

Recommended thickness:  
Tempered 10+  
Hardened 10 (pvb 1,52)  
or Tempered 10+  
Tempered 10 (pvb 1,52)

Il tirante è fornito tagliato su misura. La lunghezza viene calcolata di volta in volta rispettando gli schemi di calcolo riportati in seguito.  
L'inclinazione della struttura è regolabile di 3 cm (1,5 cm. per lato) agendo sulla filettatura destra e sinistra del tirante e tramite le viti articolate che permettono la regolazione dell'altezza.  
L'inclinazione massima ammissibile con questo sistema di calcolo è di 5°.  
Nel caso in cui venga richiesta un'inclinazione superiore, la lunghezza del cavo deve essere specificatamente calcolata.

The rod is supplied cut to size. The length is calculated from time to time respecting the calculation schemes presented below. The inclination of the structure is adjustable to 3 cm (1.5 cm. per side) acting on the thread right and left of the rod and by means of the articulated screws which allow the adjustment of the height. The maximum inclination possible with this calculation system is 5°.  
In case a higher inclination is required, the rod length has to be specifically calculated.

Calcolo tirante / Rod calculation

Distanza foro fissaggio frontale da muro / Distance of frontal fixing point from wall	altezza di fissaggio tirante / height of rod fixing point																			
	600	650	700	750	800	850	900	950	1000	1050	1100	1150	1200	1250	1300	1350	1400	1450	1500	
600	631	665	701	738	777	817	-	-	-	-	-	-	-	-	-	-	-	-	-	
650	670	702	736	772	809	847	887	928	-	-	-	-	-	-	-	-	-	-	-	
700	710	740	772	807	842	879	918	957	997	-	-	-	-	-	-	-	-	-	-	
750	-	780	810	843	877	913	950	988	1027	1067	-	-	-	-	-	-	-	-	-	
800	-	-	850	881	914	948	984	1020	1058	1097	1137	1141	-	-	-	-	-	-	-	
850	-	-	-	920	951	984	1019	1054	1091	1129	1168	1207	1247	1288	-	-	-	-	-	
900	-	-	-	-	990	1022	1055	1089	1125	1162	1199	1238	1277	1317	1358	-	-	-	-	
950	-	-	-	-	1030	1060	1092	1126	1160	1196	1232	1270	1308	1347	1387	1428	1496	-	-	
1000	-	-	-	-	1070	1100	1131	1163	1196	1231	1266	1303	1340	1379	1417	1457	1497	1538	-	
1050	-	-	-	-	-	1140	1170	1201	1233	1267	1301	1337	1374	1411	1449	1488	1527	1567	1608	
1100	-	-	-	-	-	-	1210	1240	1271	1304	1338	1372	1408	1444	1481	1519	1558	1597	1637	
1150	-	-	-	-	-	-	-	1280	1310	1342	1374	1408	1443	1478	1515	1552	1590	1628	1667	
1200	-	-	-	-	-	-	-	1320	1350	1380	1412	1445	1479	1514	1549	1585	1623	1660	1699	
1250	-	-	-	-	-	-	-	-	1390	1420	1451	1483	1516	1550	1584	1620	1656	1693	1731	
1300	-	-	-	-	-	-	-	-	-	1460	1490	1521	1553	1586	1620	1655	1691	1727	1764	
1350	-	-	-	-	-	-	-	-	-	-	1530	1560	1591	1624	1657	1691	1726	1761	1797	
1400	-	-	-	-	-	-	-	-	-	-	-	1600	1630	1662	1694	1728	1762	1796	1835	
1450	-	-	-	-	-	-	-	-	-	-	-	-	1670	1701	1732	1765	1798	1832	1867	
1500	-	-	-	-	-	-	-	-	-	-	-	-	-	1740	1771	1803	1835	1869	1903	
1550	-	-	-	-	-	-	-	-	-	-	-	-	-	-	1810	1841	1873	1906	1939	
1600	-	-	-	-	-	-	-	-	-	-	-	-	-	-	-	1850	1880	1912	1944	1977

NB:  
I valori evidenziati sono i valori con inclinazione compresa tra 40° e 50°, ottimali per il funzionamento del sistema, oltre a tali valori il tirante potrebbe recare sovra tensioni alla lastra o al muro. Non è ammesso l'utilizzo del tirante per i casi non valorizzati.  
The evidenced values are included between an inclination of 40° and 50°, these values are optimal for system functioning, over these values the rod can give extra tension to the glass and to the wall. For not quoted cases the use of the rod is not admitted.

### V-light 1



Attacco a muro inferiore  
Bottom wall connection fitting

V-LIGHT-1

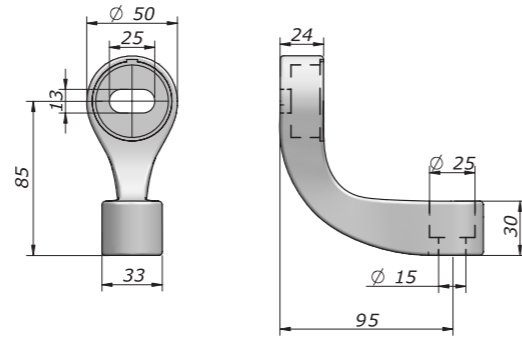

### V-light 2



Attacco a muro superiore  
Top wall connection fitting

V-LIGHT-2

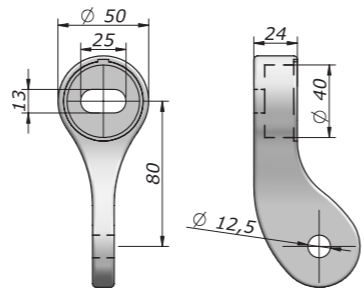

### V-light 3



Attacco a vetro multiplo  
Two ways glass connection fitting

V-LIGHT-3

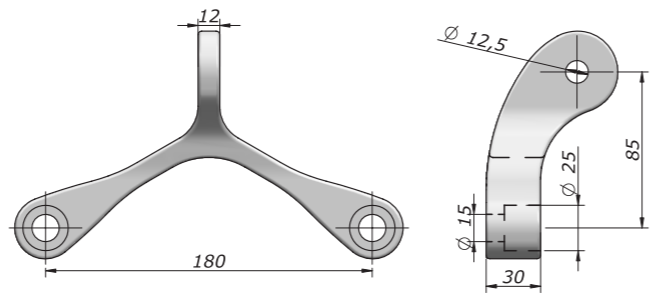

### V-light 4



Attacco a vetro singolo  
Single glass connection fitting

V-LIGHT-4

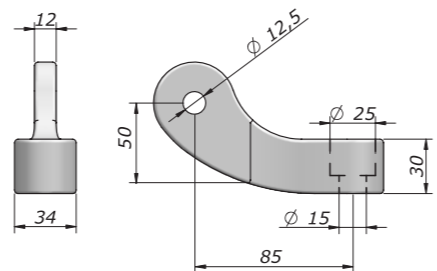

### V-light 5



Attacco a muro multiplo  
Double cable connection fitting

V-LIGHT-5

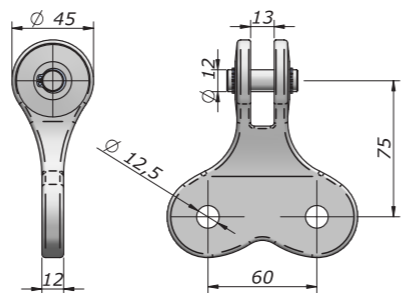

### V-light 6-150



Tirante con forcelle - lungh. da 0 a 1500 mm  
Tension rod with forks - length from 0 to 1500 mm

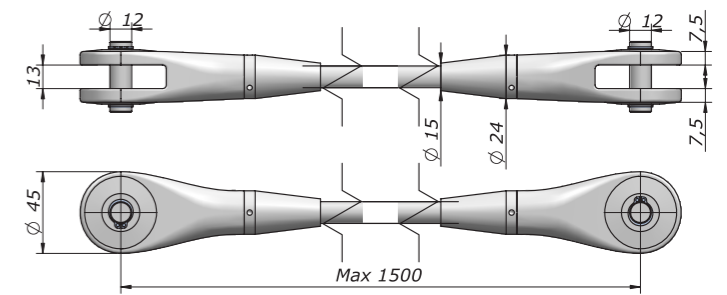

NB:  
specificare lunghezza in caso d'ordine  
length has to be specified when ordering

#### DISPONIBILI ANCHE / AVAILABLE ALSO:

- V-light 6-175: lungh. da 1501 a 1750 mm / length from 1501 to 1750 mm
- V-light 6-200: lungh. da 1751 a 2000 mm / length from 1751 to 2000 mm
- V-light 6-250: lungh. da 2001 a 2500 mm / length from 2001 to 2500 mm
- V-light 6-300: lungh. da 2501 a 3000 mm / length from 2501 to 3000 mm
- V-light 6-350: lungh. da 3001 a 3500 mm / length from 3001 to 3500 mm
- V-light 6-400: lungh. da 3501 a 4000 mm / length from 3501 to 4000 mm
- V-light 6-455: lungh. da 4001 a 4500 mm / length from 4001 to 4500 mm

### V-era N



Vite articolata per pensiline con ghiera piatta diametro 60 mm  
Articulated screw for canopy with flat ring Ø 60 mm

V-ERA-N

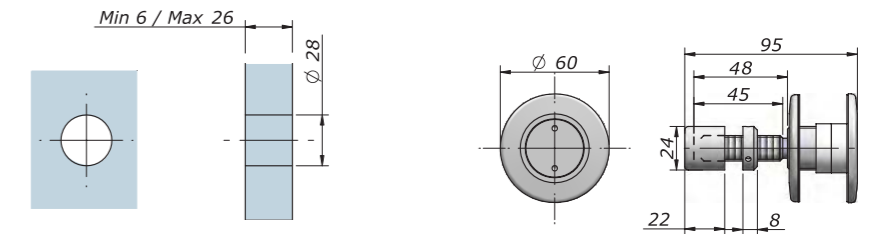

### V-era M



Vite articolata per pensiline con ghiera svasata  
Articulated screw for canopy with countersunk ring

V-ERA-M

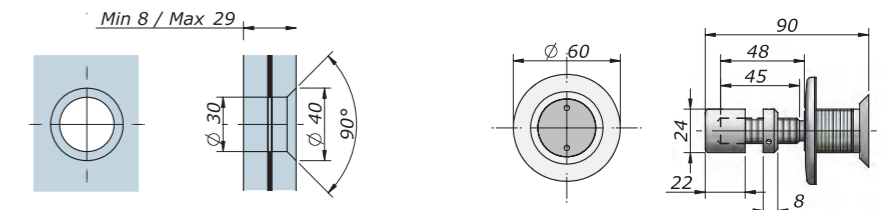

### V-AC 6



Tappo di copertura per serie Light  
Cover cap for Light series

V-AC-6

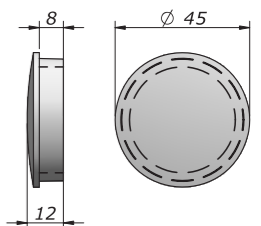





# **OXIDAL**

your\_project\_partner

**nuova oxidal srl**

via milano 42\_44  
20011 corbetta\_mi\_it  
t. +39 02 97273093  
t. +39 02 97273280  
f. +39 02 97272719  
info@nuovaoxidal.com  
www.nuovaoxidal.com